

MDM250H65E2

FEATURES

- * Low noise recovery: Ultra soft fast recovery diode.
- * High reverse recovery capability:
Super HiRC Structure.
- * High reliability, high durability diodes.
- * Isolated heat sink (terminal to base).

ABSOLUTE MAXIMUM RATINGS (T_C=25°C)

Item		Symbol	Unit	MDM250H65E2
Repetitive Peak Reverse Voltage	T _{vj} = 125°C	V _{R_{RM}}	V	6,500
	T _{vj} = 25°C			6,500
	T _{vj} = -40°C			6,000
Forward Current	DC	I _F	A	250
	1ms	I _{FM}		500
Operating Junction Temperature		T _{vj op}	°C	-40 ~ +125
Storage Temperature		T _{stg}	°C	-50 ~ +125
Isolation Test Voltage	Terminals-base	V _{ISO}	V _{RMS}	10,200(AC 1 minute)
	Terminal 1-Terminal 2	V _{ISO T-T}		10,200(AC 1 minute)
Screw Torque	Terminals (M8)	-	N·m	10 (1)
	Mounting (M6)	-		6 (2)

Notes: (1) Recommended Value 9±1N·m (2) Recommended Value 5.5±0.5N·m

ELECTRICAL CHARACTERISTICS

Item	Symbol	Unit	Min.	Typ.	Max.	Test Conditions
Repetitive Reverse Current	I _{R_{RM}}	mA	-	3.5	25	V _R =6,500V, T _{vj} =150°C
Forward Voltage Drop	V _F	V	-	3.7	-	I _F =250A, T _{vj} =25°C
			3.7	4.1	4.6	I _F =250A, T _{vj} =125°C
Reverse Recovery Time	t _{rr}	μs	-	0.6	-	V _R =3,600V, I _F =250A, L _S =200nH
Reverse Recovery Loss	E _{rr(10%)}	J/P	-	0.85	-	T _{vj} =125°C, R _G =12Ω (3)
	E _{rr(full)}	J/P	-	0.9	-	
Partial discharge extinction voltage	V _e	V _{RMS}	5,000	-	-	f=50Hz, Q _{PD} ≤10pC(acc. to IEC 61287)

Notes: (3) Counter arm; MBN500H65E2 V_{GE}=±15V

R_G value is the test condition's value for evaluation of the switching times, not recommended value.

Please, determine the suitable R_G value after the measurement of switching waveforms (overshoot voltage, etc.) with appliance mounted

PACKAGE CHARACTERISTICS

Item	Symbol	Unit	Min.	Typ.	Max.	Test Conditions
Terminal Resistance	R _{CE}	mΩ	-	0.3	-	per arm, T _{vj} =25°C
Stray inductance module	L _{SCE}	nH	-	42	-	per arm
Thermal Impedance	R _{th(j-c)}	K/W	-	-	0.051	Junction to case (per arm)
Comparative tracking index	CTI	-	-	600	-	
Contact Thermal Impedance	R _{th(c-f)}	K/W	-	0.024	-	Case to fin (per arm)

* Please contact our representatives at order.

* For improvement, specifications are subject to change without notice.

* For actual application, please confirm this spec sheet is the newest revision.

MDM250H65E2

DEFINITION OF TEST CIRCUIT

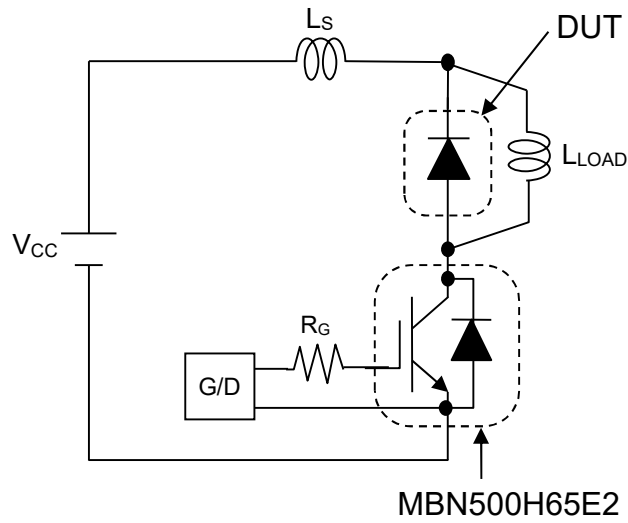

Fig.1 Switching test circuit

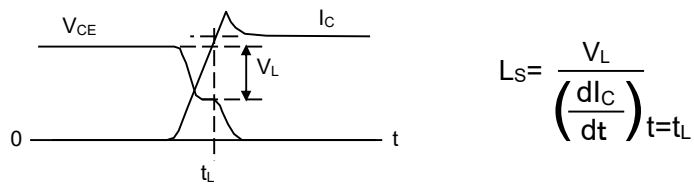

Fig.2 Definition of stray inductance

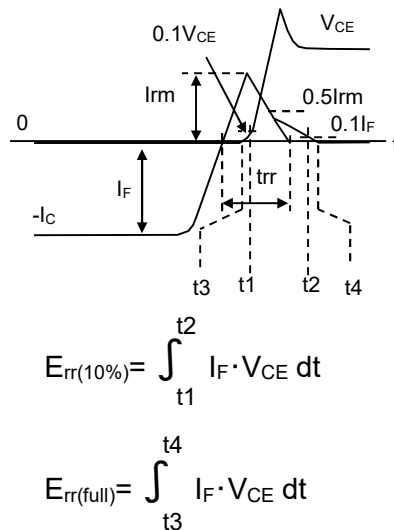
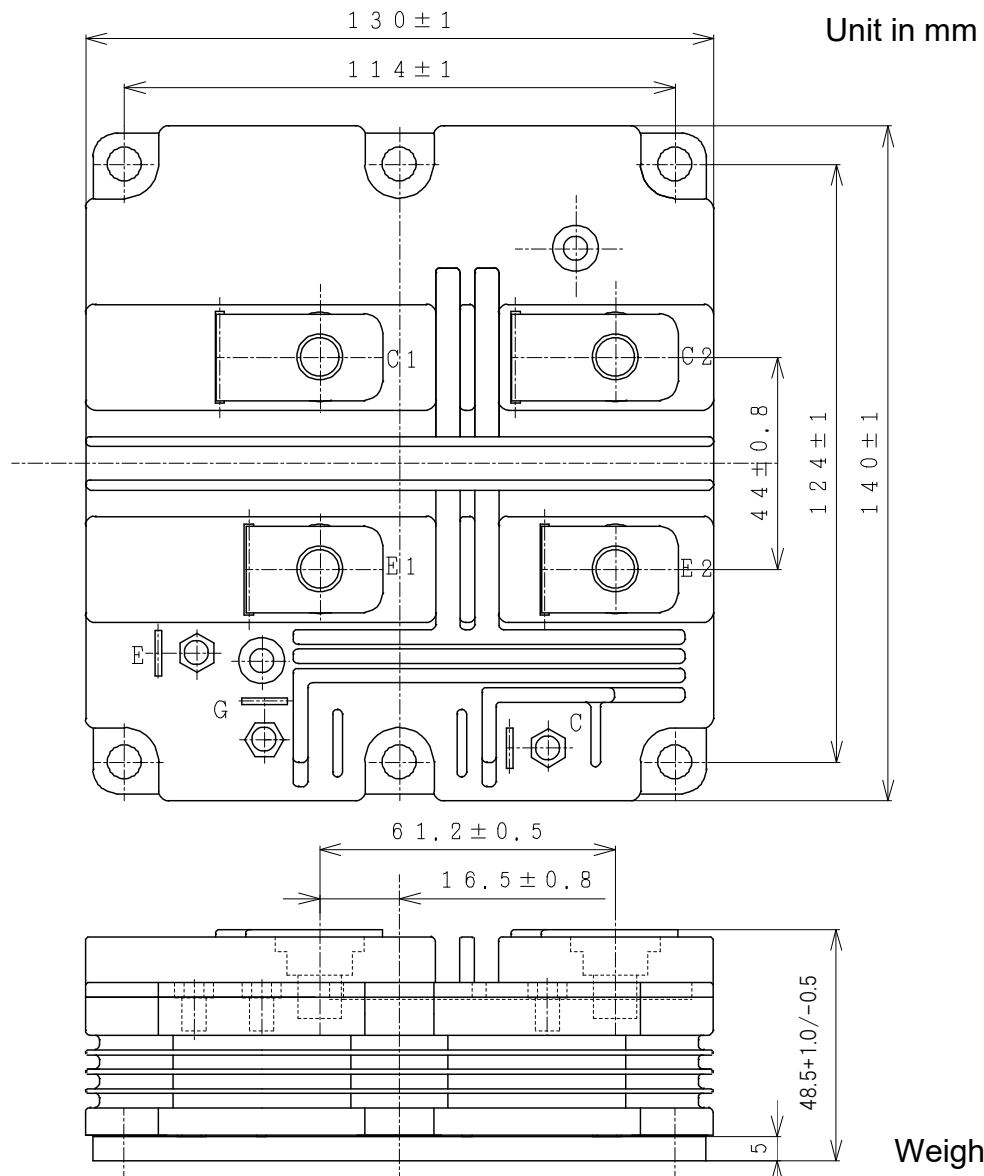

Fig.3 Definition of switching loss

MDM250H65E2

OUTLINE DRAWING



Weight: 1,050g

CIRCUIT DIAGRAM

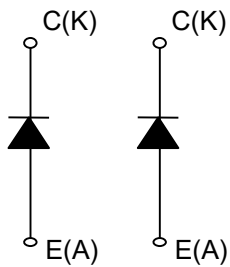

MDM250H65E2

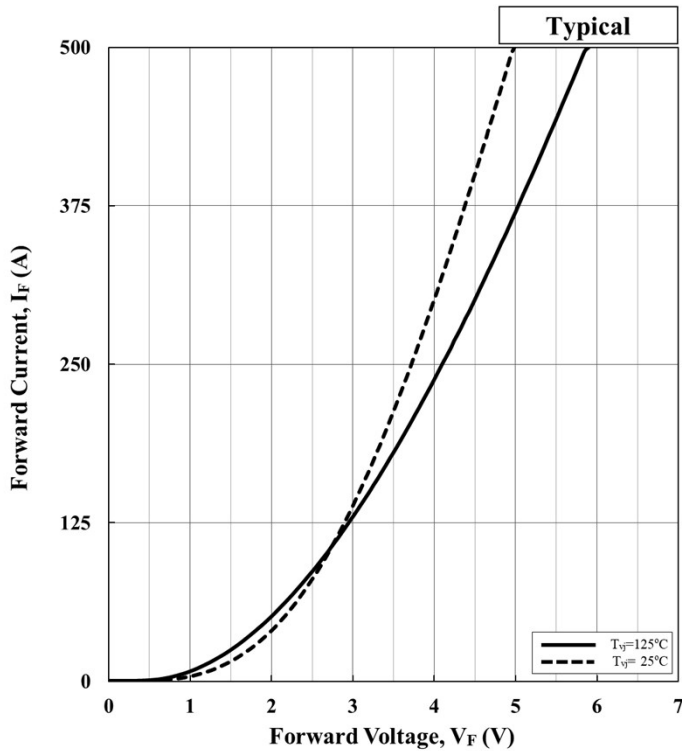

$$V_F[V] = a_3 \cdot |I_F|^3 + a_2 \cdot |I_F|^2 + a_1 \cdot |I_F| + a_0$$

Temp.[°C]	a_3	a_2	a_1	a_0
25	2.35E-08	-2.54E-05	1.38E-02	1.50E+00
125	2.31E-08	-2.65E-05	1.69E-02	1.19E+00

Forward Voltage of diode

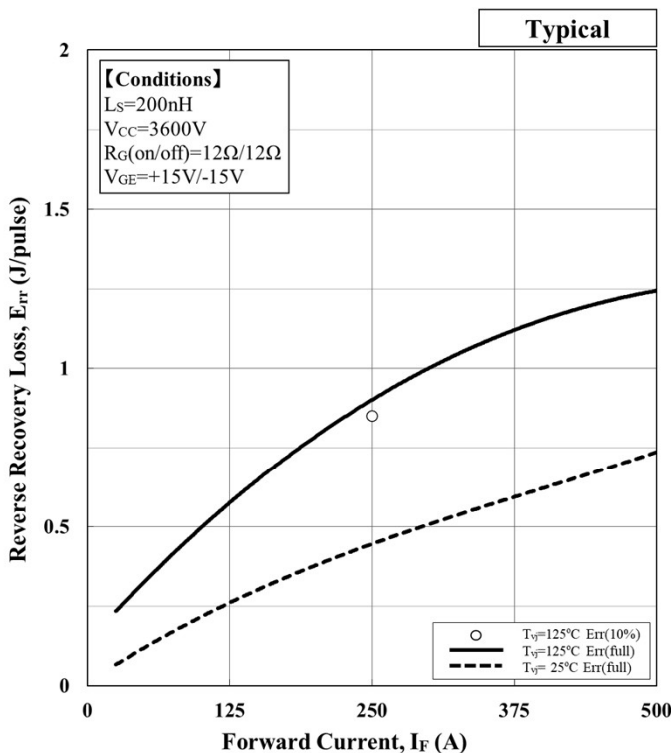

$$E [J] = a_3 \cdot |I_F|^3 + a_2 \cdot |I_F|^2 + a_1 \cdot |I_F| + a_0$$

Temp.[°C]	a_3	a_2	a_1	a_0
25	2.58E-09	-3.11E-06	2.36E-03	8.59E-03
125	8.14E-10	-3.99E-06	4.01E-03	1.36E-01

Recovery loss vs. Forward current

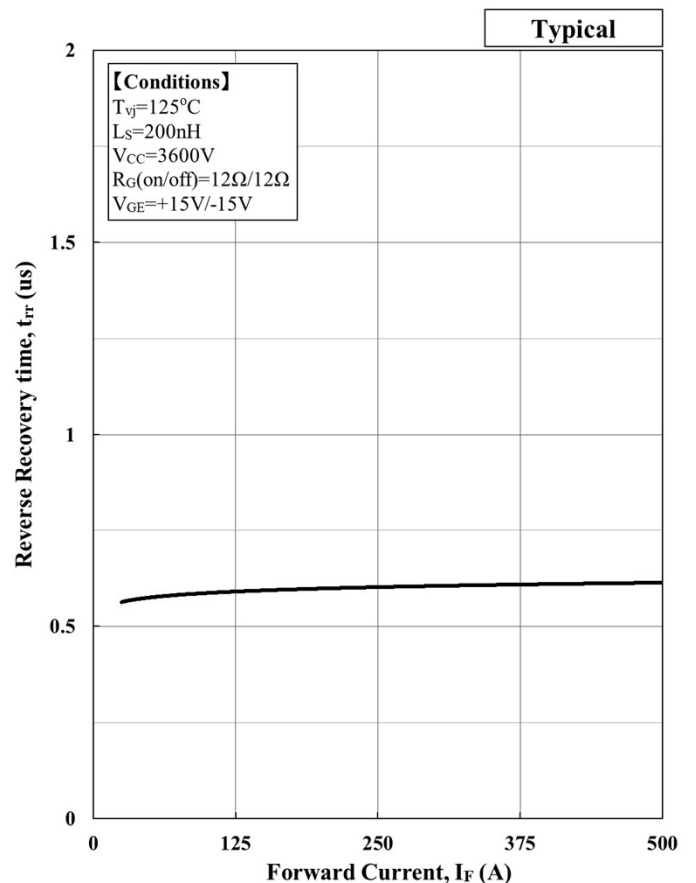

Reverse Recovery time vs. Forward Current

MDM250H65E2

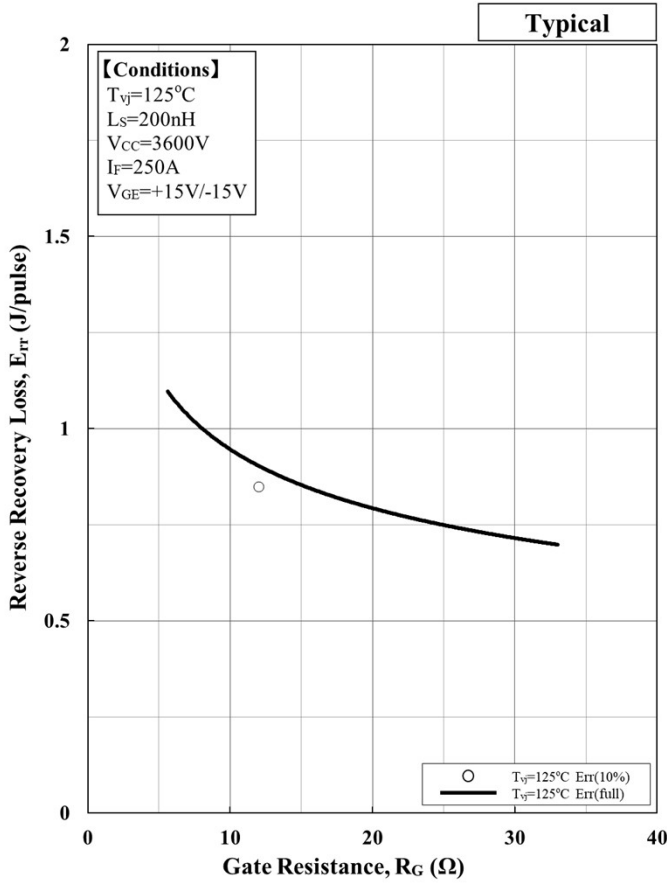

Reverse Recovery loss vs. Gate Resistance

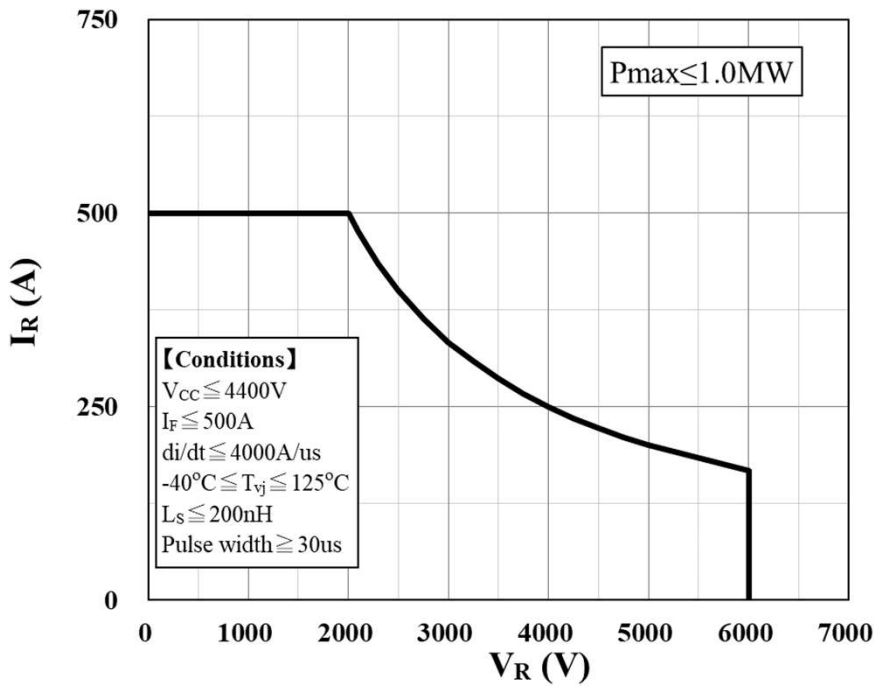

(Deined at power terminal)
 Reverse Recovery Safe Operation Area (RRSOA)

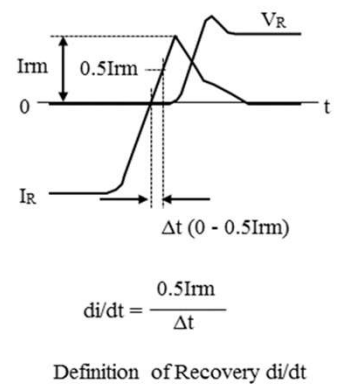

MDM250H65E2

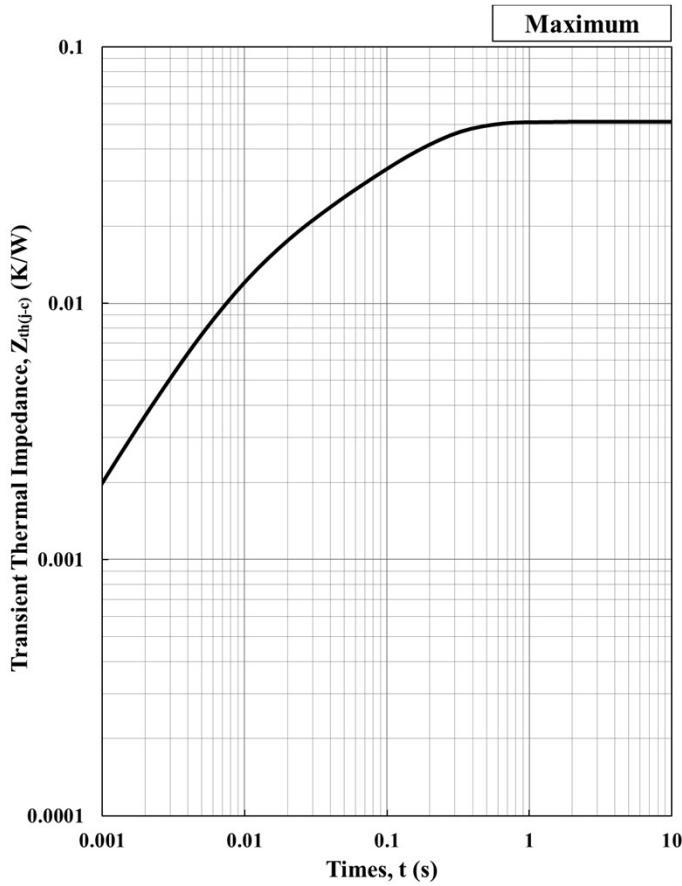

Transient Thermal Impedance Curve

Foster model lumped circuit constant

n	1	2	3	4
R th, Diode [n]	3.17E-02	9.84E-03	9.14E-03	3.88E-04
C th, Diode [n]	5.19E+00	2.92E+00	7.65E-01	2.40E+00

Cauer model lumped circuit constant

n	1	2	3	4
R th, Diode [n]	7.89E-03	1.03E-02	1.60E-02	1.67E-02
C th, Diode [n]	4.43E-01	2.55E-01	2.13E+00	5.83E+00

Material declaration

Please note the following materials are contained in the product, in order to keep characteristic and reliability level.

Material	Contained part
Lead (Pb) and its compounds	Solder

MDM250H65E2

Minebea POWER SEMICONDUCTORS

Notices

1. Since mishandling of semiconductor devices may cause malfunctions, please be sure to read "Precautions for Safe Use and Notices" in the individual brochure before use.
2. When designing an electronic circuit using semiconductor devices, please do not exceed the absolute maximum rating specified for the device under any external fluctuations. And for pulse applications, please also do not exceed the "Safe Operating Area (SOA)".
3. Semiconductor devices may sometimes break down by accidental or unexpected surge voltage, so please be careful about the safety design such as redundant design and malfunction prevention design which don't cause the damage expand even if they break down.
4. In cases where extremely high reliability is required (such as use in nuclear power control, aerospace and aviation, traffic equipment, life-support-related medical equipment, fuel control equipment and various kinds of safety equipment), safety should be ensured by using semiconductor devices that feature assured safety or by means of users' fail-safe precautions or other arrangement. Or consult with MPSD's sales department staff. (When semiconductor devices fail, as a result the semiconductor devices or wiring, wiring pattern may smoke, ignite, or the semiconductor devices themselves may burst.)
5. A semi-processed article is done now using solder which contains lead inside the semiconductor devices. There is possibility of the regulation substance depend on the applied models, so please check before using.
6. This specification is a material for component selection, which describes specifications of power semiconductor devices (hereinafter referred to as products), characteristic charts, and external dimension drawings.
7. The information given herein, including the specifications and dimensions, is subject to change without prior notice to improve product characteristics. Before ordering, purchasers are advised to contact with Minebea power semiconductor sales department for the latest version of this data sheets.
8. For handling other than described in this manual, follow the handling instructions (IGBT-HI-00002).

-
- For inquiries relating to the products, please contact nearest representatives that is located "Inquiry" portion on the top page of a home page.
-

Minebea power semiconductor home page address

<https://www.minebea-psd.com/>

<https://www.minebea-psd.com/en/>

MDM250H65E2

Minebea POWER SEMICONDUCTORS

Usage

1. MPSD warrants that the MPSD products have the specified performance according to the respective specifications at the time of its sale. Testing and other quality control techniques of the MPSD products by MPSD are utilized to the extent MPSD needs to meet the specifications described in this document. Not every device of the MPSD products is specifically tested on all parameters, except those mandated by relevant laws and/or regulations.
2. Following any claim regarding the failure of a product to meet the performance described in this document made within one month of product delivery, all the products in relevant lot(s) shall be re-tested and re-delivered. The MPSD products delivered more than one month before such a claim shall not be counted for such response.
3. MPSD assumes no obligation nor makes any promise of compensation for any fault which should be found in a customer's goods incorporating the products in the market. If a product failure occurs for reasons obviously attributable to MPSD and a claim is made within six months of product delivery, MPSD shall offer free replacement or payment of compensation. The maximum compensation shall be the amount paid for the products, and MPSD shall not assume responsibility for any other compensation.
4. MPSD reserves the right to make changes in this document and to discontinue mass production of the relevant products without notice. Customers are advised to confirm specification of the product of inquiry before purchasing of the products that the customer desired. Customers are further advised to confirm before purchasing of such above products that the product of inquiry is the latest version and that the relevant product is in mass production status if the purchasing of the products by the customer is suspended for one year or more.
5. When you dispose of MPSD products and/or packing materials, comply with the laws and regulations of each country and/or local government. Conduct careful preliminary studies about environmental laws applying to your products such as RoHS, REACH. MPSD shall not assume responsibility for compensation due to contravention of laws and/or regulations.
6. MPSD shall not be held liable in any way for damages and infringement of patent rights, copyright or other intellectual property rights arising from or related to the use of the information, products, and circuits in this document.
7. No license is granted by this document of any patents, copyright or other intellectual property rights of any third party or of MPSD.
8. This document may not be reprinted, reproduced or duplicated, in any form, in whole or in part without the express written permission of MPSD.
9. You shall not use the MPSD products (technologies) described in this document and any other products (technologies) manufactured or developed by using them (hereinafter called "END Products") or supply the MPSD products (technologies) and END Products for the purpose of disturbing international peace and safety, including (i) the design, development, production, stockpiling or any use of weapons of mass destruction such as nuclear, chemical or biological weapons or missiles, (ii) the other military activities, or (iii) any use supporting these activities. You shall not sell, export, dispose of, license, rent, transfer, disclose or otherwise provide the MPSD products (technologies) and END Products to any third party whether directly or indirectly with knowledge or reason to know that the third party or any other party will engage in the activities described above.
When exporting, re-export transshipping or otherwise transferring the MPSD products (technologies) and END Products, all necessary procedures are to be taken in accordance with Foreign Exchange and Foreign Trade Act (Foreign Exchange Act) of Japan, Export Administration Regulations (EAR) of US, and any other applicable export control laws and regulations promulgated and administered by the governments of the countries asserting jurisdictions over the parties or transaction.